



TimeSmartSM
Tips Inside!

Use & Care

G U I D E

Standard-Cleaning Electric Ranges

A Note to You	2
Range Safety	3-5
Getting to Know Your Range	6
Using Your Range	7
Caring for Your Range	19
Troubleshooting	26
Requesting Assistance or Service	27
Index	31
Warranty	32

1-800-253-1301

Call our Consumer Assistance Center
with questions or comments.

Super Capacity 465

4.65 Cubic Foot Oven

MODELS RF3020XE RF302BXE

PART NO. 3195946



A NOTE TO YOU

Thank you for buying a WHIRLPOOL® appliance.

Because your life is getting busier and more complicated, WHIRLPOOL ranges are easy to use, save time, and help you manage your home better. To ensure that you enjoy years of trouble-free operation, we developed this Use and Care Guide. It is full of valuable information about how to operate and maintain your appliance properly and safely. Please read it carefully. Also, complete and mail the **Product Registration Card** provided with your appliance. The card helps us notify you about any new information on your appliance.

Please record your model's information.

Whenever you call to request service for your appliance, you need to know your complete model number and serial number. You can find this information on the model and serial number plate (see the diagram on page 6 for the location of the plate). Also, record the other information shown in the next column.

TimeSmartSM TIPS

Look for these tips!

Look for these Time Smart Tips located throughout your Use and Care Guide. They will help you save time and make the most of your new appliance.

Model Number _____

Serial Number _____

Purchase Date _____

Dealer Name _____

Dealer Address _____

Dealer Phone _____

Keep this book and the sales slip together in a safe place for future reference.

Our Consumer Assistance Center number is toll-free. 1-800-253-1301

RANGE SAFETY

Your safety is important to us.

This guide contains safety statements under warning symbols. Please pay special attention to these symbols and follow any instructions given. Here is a brief explanation of the use of the symbol.



This symbol alerts you to hazards such as fire, electrical shock, or other injuries.

IMPORTANT SAFETY INSTRUCTIONS

WARNING

To reduce the risk of fire, electrical shock, injury to persons, or damage when using the range, follow basic precautions, including the following:

General

- Read all instructions before using the range.
- Install or locate the range only in accordance with the provided Installation Instructions. The range must be installed by a qualified installer. The range must be properly connected to electrical supply and grounded.



- **WARNING:** To reduce the risk of tipping the appliance, the appliance must be secured by a properly installed anti-tip bracket. To check if the bracket is installed properly, see "The anti-tip bracket" on page 17.
- **CAUTION:** Do not store things children might want above the range. Children could be burned or injured while climbing on it.
- Do not leave children alone or unattended in area where the range is in use. They should never be allowed to sit or stand on any part of the range. They could be burned or injured.
- Do not operate the range if it is damaged or not working properly.

- Do not use the range for warming or heating the room. Persons could be burned or injured, or a fire could start.
- Use the range only for its intended use as described in this manual.



- Do not touch surface units, areas near units, heating elements, or interior surfaces of oven. Surface units and heating elements may be hot even though they are dark in color. Areas near surface units and interior surfaces of an oven become hot enough to cause burns. During and after use, do not touch or let clothing or other flammable materials contact surface units, areas near units, heating elements, or interior surfaces of oven until they have had sufficient time to cool. Other surfaces of the range, such as the oven vent opening, the surface near the vent opening, the cooktop, and the oven door, could also become hot enough to cause burns.

continued on next page



- Do not wear loose or hanging garments when using the range. They could ignite if they touch a hot surface unit and you could be burned.
- Use only dry pot holders. Moist or damp pot holders on hot surfaces could result in burns from steam. Do not let pot holder touch hot heating elements. Do not use a towel or bulky cloth for a pot holder. It could catch on fire.
- Keep range vents unobstructed.
- Do not heat unopened containers. They could explode. The hot contents could cause burns and container particles could cause injury.
- Use only cookware approved for oven use. Follow cookware manufacturer's instructions, especially when using glass or plastic cookware.
- Do not store flammable materials on or near the range. The fumes could create an explosion and/or fire hazard.

When using the cooktop

- Make sure the reflector bowls are in place during cooking. Cooking without reflector bowls could subject the wiring and components underneath them to damage.

- Do not line reflector bowls with aluminum foil or other liners. Improper installation of these liners could result in a risk of electric shock or fire.
- Select a pan with a flat bottom that is about the same size as the surface unit. If pan is smaller than the surface unit, some of the heating element will be exposed and could result in the igniting of clothing or pot holders. Correct pan size also improves cooking efficiency.
- Check to be sure glass cookware is safe for use on the range. Only certain types of glass, glass-ceramic, ceramic, earthenware, or other glazed cookware are suitable for cooktops without breaking due to the sudden change in temperature.
- Never leave surface units unattended at high heat settings. A boilover could result and cause smoking and greasy spillovers that could ignite.



- Turn pan handles inward, but not over other surface units. This will help reduce the chance of burns, igniting of flammable materials, and spills due to bumping of the pan.

When using the oven

- Always position oven rack(s) in desired location while oven is cool. If a rack must be removed while oven is hot, do not let pot holder contact hot heating elements in oven.
- Use care when opening oven door. Let hot air or steam escape before removing or replacing food.

Grease

- Grease is flammable. Do not allow grease to collect around cooktop or in vents. Wipe spillovers immediately.



- Do not use water on grease fires. Never pick up a flaming pan. Smother flaming pan on range by covering with a well-fitting lid, cookie sheet, or flat tray. Flaming grease outside of pan can be extinguished with baking soda or, if available, a multipurpose dry chemical or foam-type extinguisher.

Care and cleaning

- Do not soak removable heating elements in water. The element will be damaged and shock or fire could result.
- Do not clean door heat seal. It is essential for a good seal. Care should be taken not to rub, damage, or move the seal. Clean only parts recommended in this Use and Care Guide.
- Do not repair or replace any part of the range unless specifically recommended in this manual. All other servicing should be referred to a qualified technician.
- Disconnect the electrical supply before servicing the range.

– SAVE THESE INSTRUCTIONS –

GETTING TO KNOW YOUR RANGE

This section contains captioned pictures of your range. Use them to learn where all parts and features are and what they look like. Use the page references to help you quickly find out more about the part or feature you are interested in.

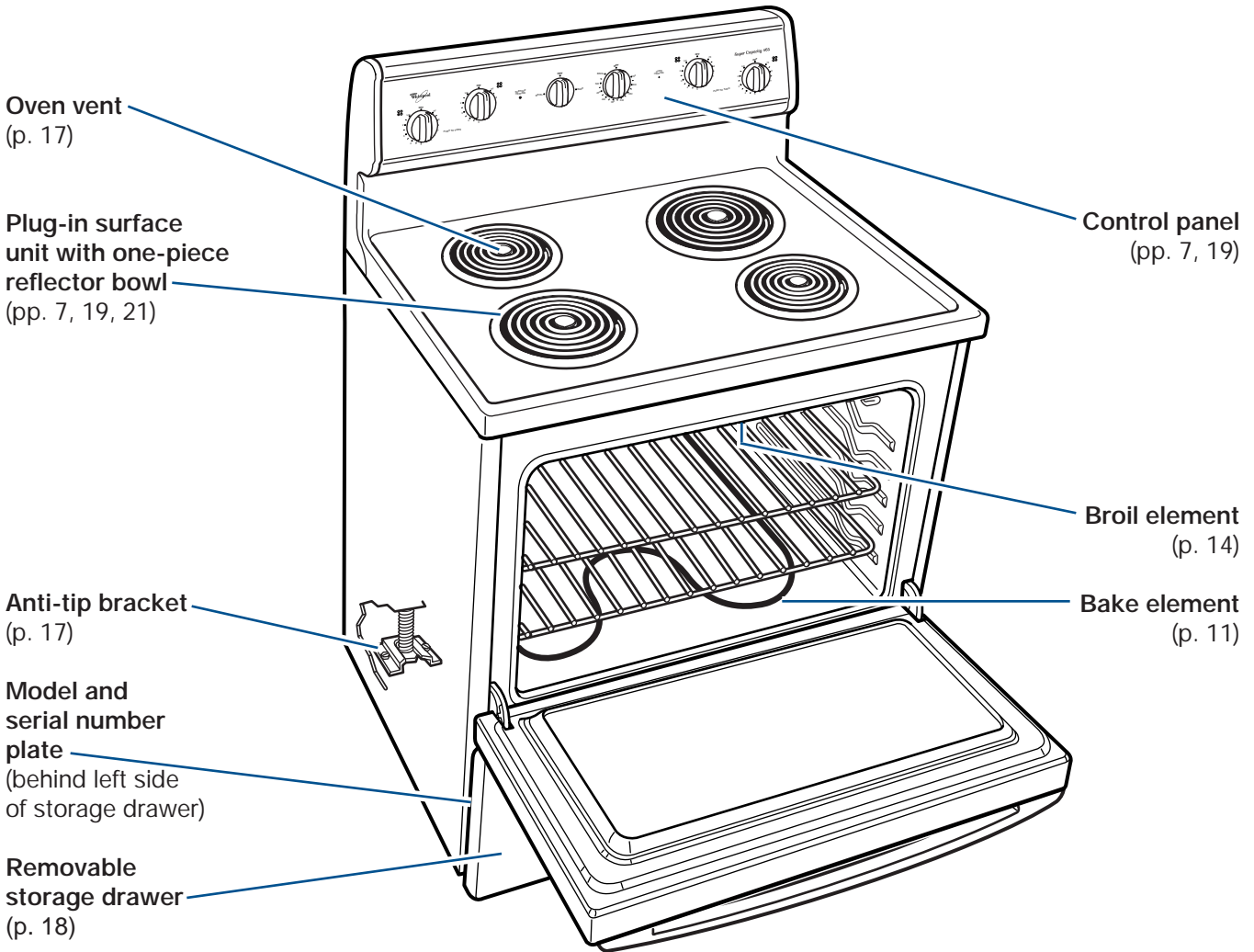

CONTROL PANEL

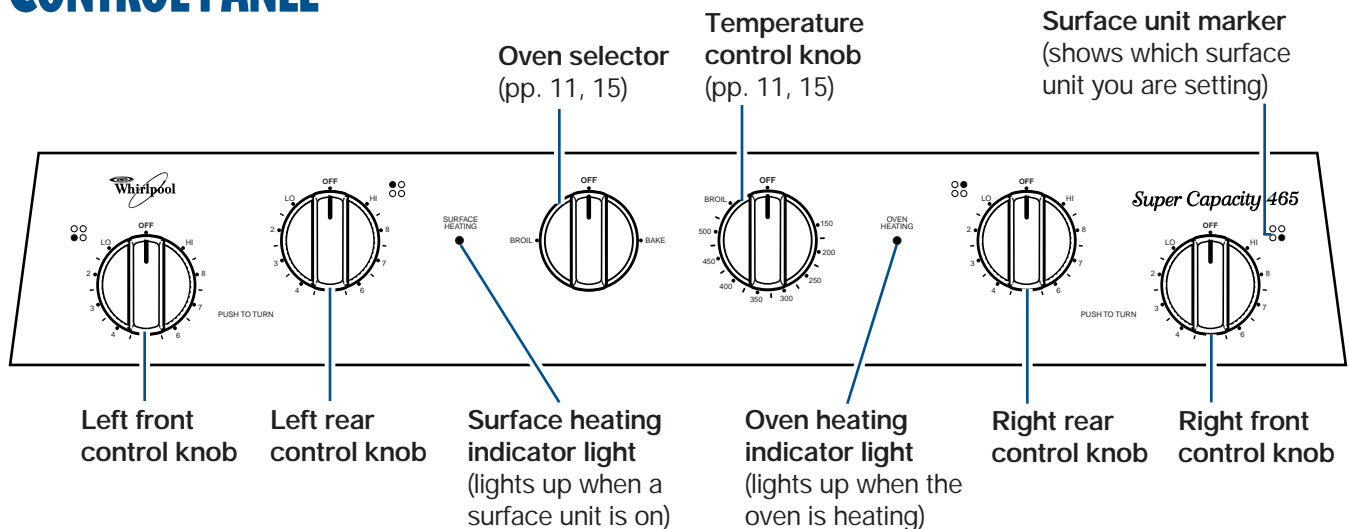

USING YOUR RANGE

To get the best cooking results, you should use your range the correct way. This section tells you what you need to know to use your range safely and efficiently.

USING THE SURFACE UNITS

Using the control knobs

Push in the control knobs before turning them to a setting. You can set them anywhere between HI and OFF.

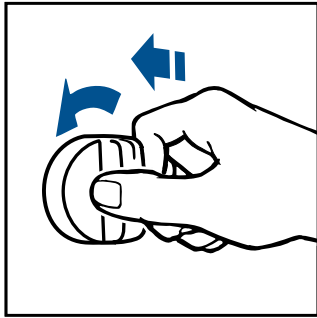

Surface unit heat settings

Use the following chart as a guide.

SETTING	RECOMMENDED USE
HI	<ul style="list-style-type: none">• To start foods cooking.• To bring liquids to a boil.
6-8	<ul style="list-style-type: none">• To hold a rapid boil.• To fry chicken or pancakes.
5	<ul style="list-style-type: none">• For gravy, pudding, and icing.• To cook large amounts of vegetables.
2-4	<ul style="list-style-type: none">• To keep food cooking after starting it on a higher setting.
LO	<ul style="list-style-type: none">• To keep food warm until it's ready to serve.

⚠ WARNING



Fire Hazard

Turn all controls off when done cooking. Failure to do so can result in death, fire, or burns.

TimeSmartSM TIPS

Easy ways to save energy

- Match the pan to the surface unit size.
- The pan should have a flat bottom, straight sides, and a well-fitting lid.
- To help shorten your cooking time, use the least amount of liquid possible.
- Preheat your pans only when recommended and for the shortest time possible.
- Start your food on a higher heat setting, then turn the control to a lower setting to finish cooking.
- Place a filled pan on the surface unit before turning it on.
- Keep your reflector bowls clean for best heat reflection.

USING THE SURFACE UNITS (CONT.)

Using cookware

- Use the correct cookware to prevent damage to the surface unit, cooktop, wiring, and surrounding areas.
- If the cookware is too small for the surface unit or the bottom is not flat, the surface unit could stay glowing red for an extended length of time causing damage to the unit.
- If you start cooking on high, it is important to turn the control down to a lower setting to complete cooking.
- The surface unit could overheat or be damaged if a pot has boiled dry or has been left empty on a hot surface unit.

TimeSmartSM TIPS

Using the right cookware makes a big difference

- Flat bottomed cookware, including woks, canners, and teakettles, will provide better contact with the surface unit and provide the best cooking results.
- Warped, dented, and ribbed-bottomed cookware can result in uneven cooking due to incomplete contact with the surface unit.
- Cookware that has been designed with slightly indented bottoms or small expansion channels can be used.
- Choose medium to heavy gauge (thickness) cookware.
- The pan material (type of metal or glass) affects how quickly and evenly the pan heats.

Home canning information

To protect your range:

- Use flat-bottomed canners/pans for best results.

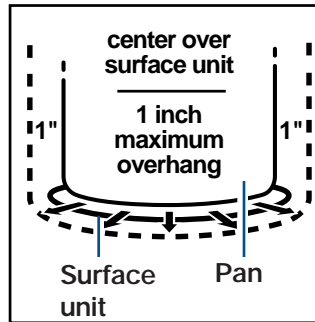

centered correctly, trap heat and can cause damage to the cooktop.

- Do not place your canner on two surface units at the same time. Too much heat will build up and will damage the cooktop.

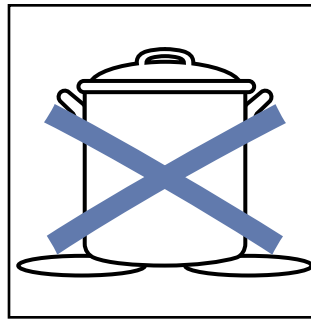

- Use the largest surface unit for best results. Also, use a canner/pan that you can center over the surface unit and that does not extend more than one inch outside the surface unit area. Large diameter canners/pans, if not centered correctly, trap heat and can cause damage to the cooktop.
- Start with hot water. This reduces the time the control is set on high. Reduce the heat setting to the lowest position needed to keep water boiling.
- To keep your elements working for as long as possible:
 - Prepare small batches at a time.
 - Do not use your elements for canning all day.
- Keep your reflector bowls clean so that they will always reflect heat well.
- Refer to your canner manual for specific instructions.

Optional canning kit

Most water-bath or pressure canners have large diameters. If you do canning with them at high heat settings for long periods of time, you can shorten the life of regular surface units. This can also damage the cooktop. If you plan to use the cooktop for canning, we recommend the installation of a Canning Kit. Order the kit (Part No. 242905) from your Whirlpool dealer or authorized Whirlpool service company.

POSITIONING RACKS AND PANS

General guidelines

Follow this section carefully to get the best cooking results.

- Before turning on the oven, place oven racks where you need them.
- To move a rack, pull it out to the stop, raise the front edge, and lift it out.
- Be sure the rack(s) is level.
- Use pot holders or oven mitts to protect your hands if rack(s) must be moved while the oven is hot.
- When baking/roasting with 1 rack, place the rack so the top of the food will be centered in the oven.
- When baking/roasting on 2 racks, arrange the racks on the 2nd and 4th rack guides from the bottom.
- Do not place items on the oven door when it is open.

Rack placement for specific foods:

FOOD	RACK POSITION
Frozen pies, large roasts, turkeys, angel food cakes	1st or 2nd rack guide from bottom
Bundt cakes, most quick breads, yeast breads, casseroles, meats	2nd rack guide from bottom
Cookies, biscuits, muffins, cakes, nonfrozen pies	2nd or 3rd rack guide from bottom

NOTE: For information on where to place your rack when broiling, see "Broiling guide" on page 16.

TimeSmartSM TIPS

Using insulated bakeware, ovenproof glassware, and dark metal pans

- When baking with insulated cookie sheets or baking pans, place them in the bottom third of the oven. You may need to increase the recommended baking times, so test for doneness before removing from the oven.
- When using ovenproof glassware or dark bakeware, reduce the oven temperature by 25°F but use the same baking time. Because these pans absorb heat, producing darker bottom browning and crispier crusts, place the rack in the center of the oven. When baking pies and bread, you can use the temperature suggested in the recipe.

FOR BEST AIR CIRCULATION

Hot air must circulate around the pans in the oven for even heat to reach all parts of the oven. This results in better baking.

- Place the pans so that one is not directly over the other.
- For best results, allow 1½-2 inches of space around each pan and between pans and oven walls.
- Use only one cookie sheet in the oven at a time.

Where to place pans:

WHEN YOU HAVE	PLACE
1 pan	In center of the oven rack.
2 pans	Side by side or slightly staggered.
3 or 4 pans	In opposite corner on each oven rack. Stagger pans so no pan is directly over another.

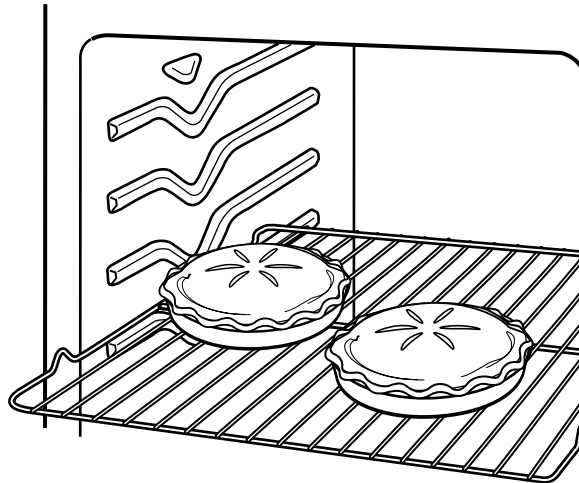

USING ALUMINUM FOIL FOR BAKING

Use aluminum foil to catch spillovers from pies or casseroles:

- Place the foil on the oven rack below the rack with the food. Turn up the foil edges and make sure the foil is about 1 inch larger all around than the dish holding the food.
 - Do not cover the entire rack with aluminum foil. It will reduce air circulation and give you poor cooking results.

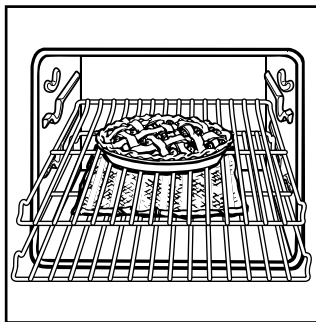

- Do not line the oven bottom or the entire oven rack with foil or other liners. It could affect the quality of your baking.

BAKING/ROASTING

1. Place the racks where you need them.
For more information, see "Positioning racks and pans" on page 9.

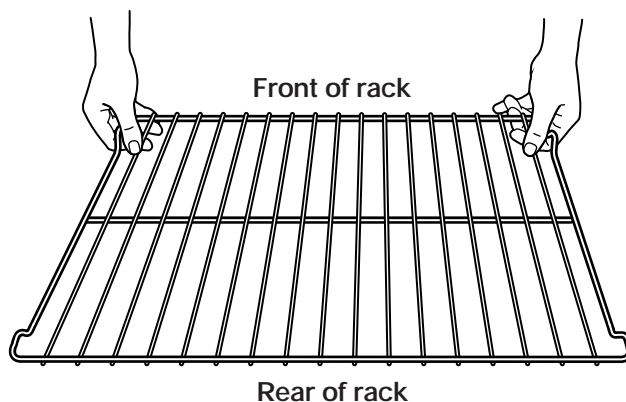

2. Set the oven selector to BAKE and the oven temperature control knob to the baking/roasting temperature you want.
The oven heating indicator light will come on. The oven is preheated when the oven heating indicator light first goes off.

NOTE: Do not preheat the oven when roasting.

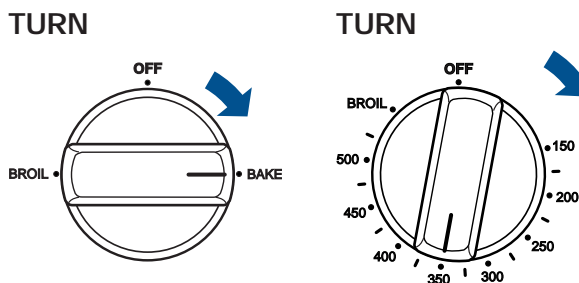

3. Put your food in the oven.
During baking/roasting, the elements will turn on and off to keep the oven temperature at the setting. The oven heating indicator light will turn on and off with the elements.

NOTE: The top element helps heat during baking/roasting, but does not turn red.

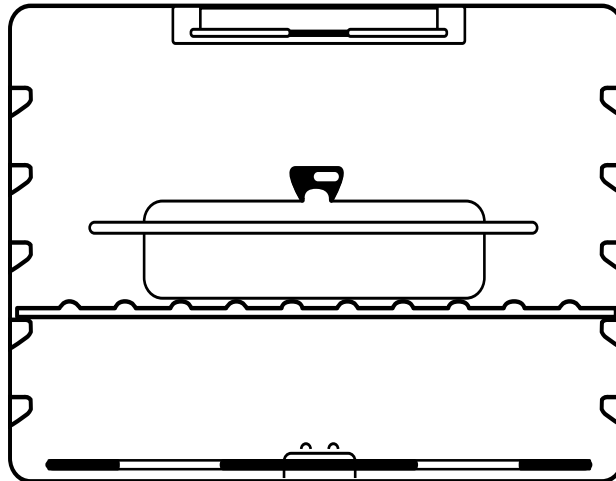

TimeSmartSM TIPS

Roasting meats and poultry

- For even cooking, place the meat on a rack in a shallow pan. This keeps the meat out of the drippings and allows the heat to circulate better.
- Use a meat thermometer for the most accurate doneness. Insert it so the tip is in the center of the largest muscle or thickest portion of the meat or poultry. Make sure the thermometer is not touching bone, fat, or the bottom of the pan.

continued on next page

BAKING/ROASTING (CONT.)

4. After cooking, turn off the oven.

Turn both the oven selector and the oven temperature control knob to OFF. The oven heating indicator light will go off.

TimeSmartSM TIPS

Save energy and save money

- “Oven peeking” can make cooking times longer and affect food quality.
- Rely on a timer to keep track of cooking time.
- Plan your meals for the most efficient use of the oven by cooking more than one food at a time.
- If possible, plan to bake while the oven is still hot after cooking.
- You don’t have to preheat the oven when broiling or roasting.

TURN

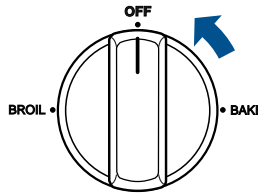

TURN

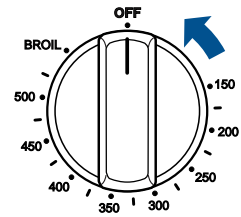

ADJUSTING THE OVEN TEMPERATURE CONTROL

Although your new oven is properly adjusted to provide accurate temperatures, it may cook faster or slower than your old oven.

If you are not satisfied with the baking/roasting results, you can change the temperature calibration by following the steps below.

NOTE: DO NOT measure the oven temperature with a thermometer. Opening the oven door will lower the oven temperature and give you an incorrect reading. Also, the thermometer temperature reading will change as your oven cycles.

1. Make sure the oven temperature control knob is turned to the off position. Pull the knob straight off and flip it over.

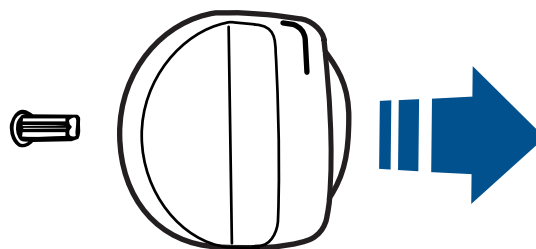

2. Loosen the locking screws inside the control knob.

Note the position of the notches.

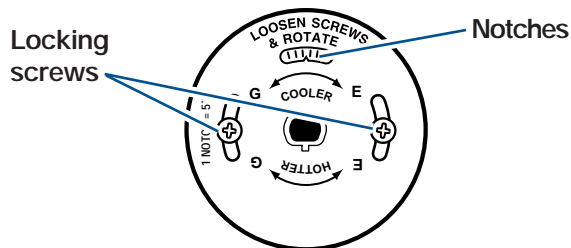

3. Adjust the temperature.

- **To lower the temperature**, hold the knob handle firmly and turn the skirt **clockwise** to move the tooth a notch to the right.
- **To raise the temperature**, hold the knob handle firmly and turn the skirt **counterclockwise** to move the tooth a notch to the left.

Each notch equals about 5°F.

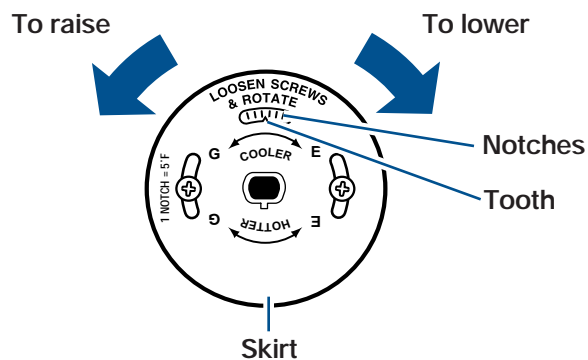

4. Tighten the locking screws and replace the control knob.

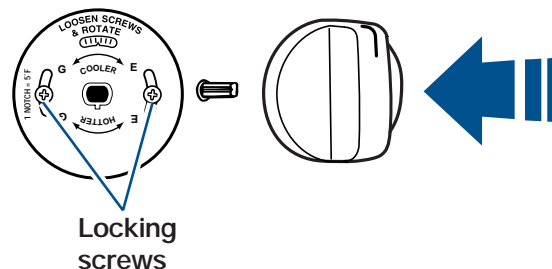

BROILING

NOTES:

- Do not preheat when broiling.
- The oven selector must be on BROIL for broiling temperatures
- Leave the door partly open whenever you use the oven to broil. This lets the oven stay at the proper temperatures.

1. Place the rack where you need it.

You need to place the rack so that the surface of the food is at least 3 inches away from the broil element. See "Broiling guide" on page 16.

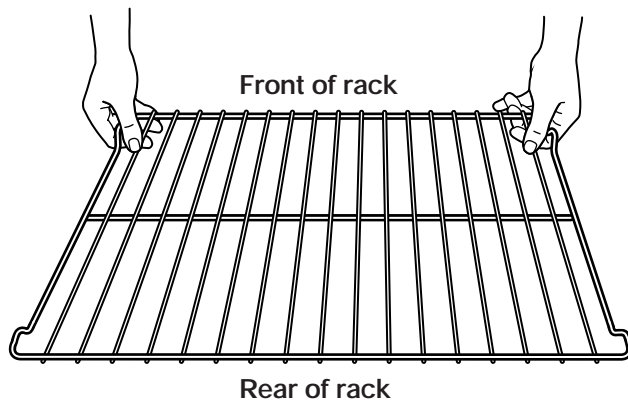

2. Put your food on the broiler pan and place the pan in the center of the oven rack.

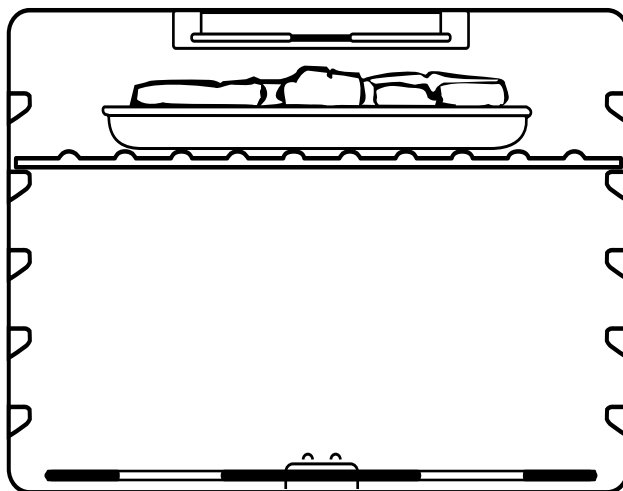

3. Close the door to the broil stop position.

The broil stop position lets the door stay open by itself about 5 inches.

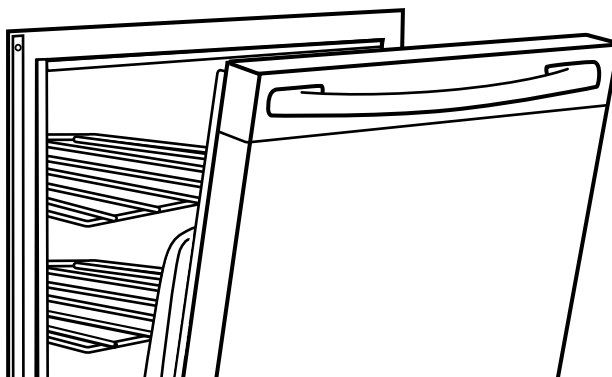

BROILING (CONT.)

4. Set the oven selector and the oven temperature control knob to BROIL.

The oven heating indicator light will come on.

TURN

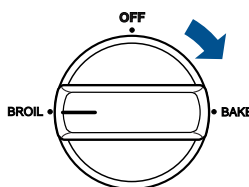

TURN

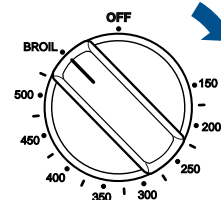

5. After broiling, turn off the oven.

Turn both the oven selector and the oven temperature control knob to OFF. The oven heating indicator light will go off.

TURN

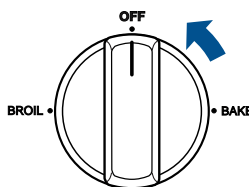

TURN

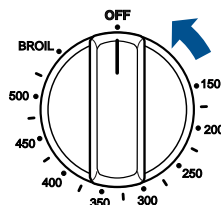

If you want to broil at a lower temperature:

- If your food is cooking too fast, turn the oven temperature control knob **counterclockwise** until the oven heating indicator light goes off.

TURN

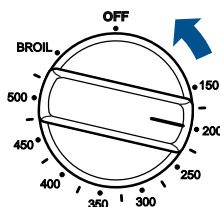

- If you want your food to broil slower from the start, set the oven temperature control knob between 170°F and 325°F. These temperature settings let the broil heating element cycle and slow cooking. The lower the temperature, the slower the cooking.

TURN

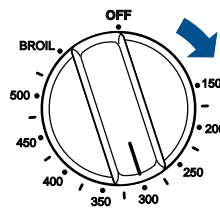

NOTE: Fish and chicken are some foods that may cook better if you use lower broiling temperatures.

BROILING TIPS

- Use the broiler pan and grid for broiling. They are designed to drain extra liquid and grease away from the cooking surface. This drainage helps prevent spatter, smoke, or fire.
- Do not cover the broiler grid with foil.
- To make sure the grease drains well, do not use cookie sheets or similar pans for broiling.
- Place food about 3" or more from the broil element.
- After broiling, remove the broiler pan from the oven when you remove the food. Drippings will bake on the pan if you leave it in the heated oven.

Broiling guide

Recommended rack positions are numbered from the bottom (1) to the top (5). For best results, turn meat after approximately $\frac{2}{3}$ of the broiling time. Turn chicken pieces after approximately half of the broiling time. Very thin cuts, such as fish fillets, may not need to be turned at all. Lobster tails are not turned.

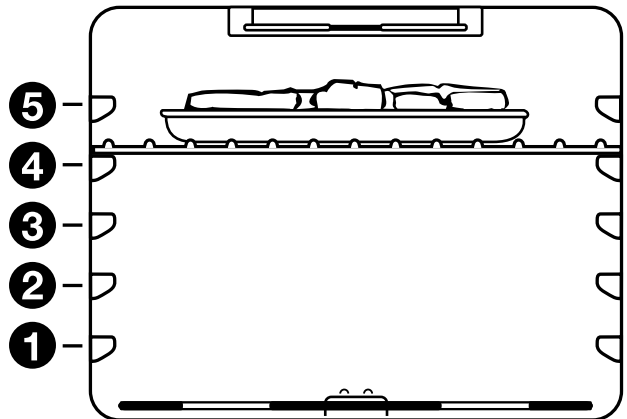

MEAT	RACK POSITION	APPROXIMATE TIME (MINUTES)	
		SIDE 1	SIDE 2
Steak, 1" thick	4		
medium rare		14-15	7-8
medium		15-16	8-9
well done		18-19	9-10
Hamburger Patties, $\frac{3}{4}$ " thick, $\frac{1}{4}$ lb well done	4	13-14	7-8
Pork Chops, 1" thick	4	20-22	10-11
Ham Slice, $\frac{1}{2}$ " thick precooked	4	8-10	4-5
Frankfurters	4	5-7	3-4
Lamb Chops, 1" thick	4	14-17	8-9
Chicken			
bone-in pieces	3	17-20	17-20
boneless breasts	4	11-16	11-16
Fish	4		
fillets $\frac{1}{4}$ - $\frac{1}{2}$ " thick		8-10	4-5
steaks, $\frac{3}{4}$ -1" thick		16-18	8-9
Lobster Tails, 6-8 oz	3	17-20	N/A

Times are guidelines only and may need to be adjusted for individual tastes.

THE OVEN VENT

⚠️ WARNING



Fire Hazard

Use pot holders to move utensils left on the left rear surface unit.

Keep flammable materials away from the oven vent.

Failure to follow these precautions can result in death, fire, or burns.

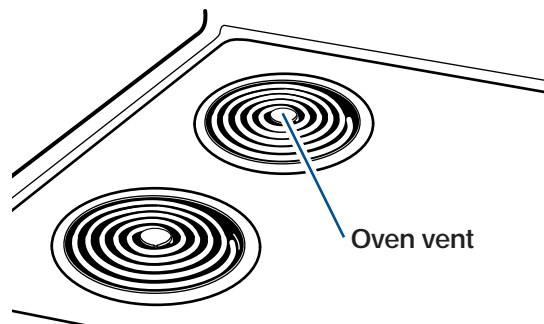

Hot air and moisture escape from the oven through a vent under the left rear surface unit. You can cook on this unit or keep food warm on it while the oven is on. The vent is needed for air circulation.

Do not block the vent by using extra large pans or covers. You will get poor baking/roasting results.

NOTE: Never leave plastic utensils over the vent. They could melt.

THE ANTI-TIP BRACKET

The range will not tip during normal use. However, the range can tip if you apply too much force or weight to the open door without the anti-tip bracket fastened down properly.



⚠️ WARNING

Tip Over Hazard

Connect anti-tip bracket to the range feet.

Reconnect anti-tip bracket, if the range is moved.

Do not push down on the open oven door.

Follow the Installation Instructions.

Do not let children climb onto the oven door.

Failure to follow the above can result in death, burns, or other injury.

To make sure the anti-tip bracket is fastened into place:

- Remove the storage drawer (see "The storage drawer" on page 18).
- Look under the range (you may need a flashlight). Check that a leveling leg is positioned under the bracket.
- See the Installation Instructions for further details.

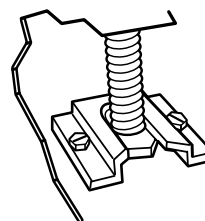

THE STORAGE DRAWER

You can remove the storage drawer to make it easier to clean under your range and to make sure the anti-tip floor bracket is installed. **Be careful when handling the drawer.**

Removing the storage drawer:

1. Empty the drawer before you remove it. Pull the drawer straight out to the first stop. (The stops are small, round objects formed in the slide rail. They keep the drawer from sliding all the way out.) Then lift the front of the drawer and pull it out to the second stop.
2. Lift the back of the drawer slightly and slide it all the way out.

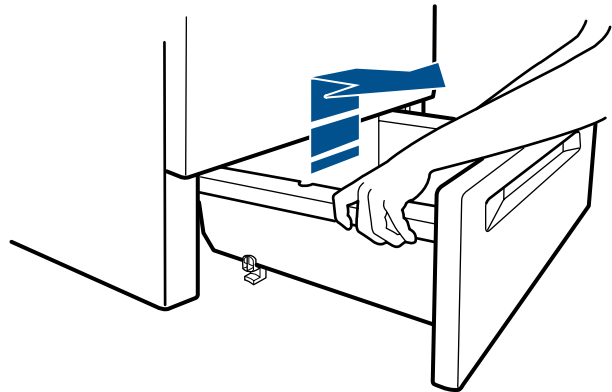

Replacing the storage drawer:

1. Fit the ends of the drawer slide rails into the drawer guides on both sides of the opening. Also, be sure the lower guide is fitted onto the lower slide rail.
2. Lift the front of the drawer and push it in until the metal stops on the drawer slide rails clear the drawer guides. Then slide the drawer closed.

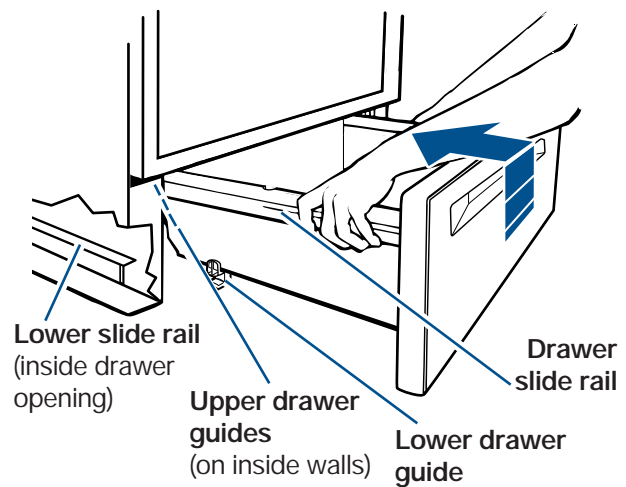

CARING FOR YOUR RANGE

Your range is designed so you can care for it easily. You can do most cleaning with items found around your home. Cleaning your range whenever spills or soiling occurs will help to keep it looking and working like new.



⚠️ WARNING

Electrical Shock Hazard

Make sure all controls are off and the range is cool before cleaning. Failure to do so can result in death, electrical shock, or burns.

CLEANING CHART

Use this chart to get specific information on cleaning your range. **Before cleaning, always make sure all controls are off and the range is cool.**

PART	HOW TO CLEAN
Control knobs	<ol style="list-style-type: none"> 1. Turn the knobs off and pull them straight away from the control panel. 2. Wash the knobs with a sponge and warm, soapy water. Rinse and dry them well. Do not soak them. Do not use steel wool or gritty cleansers, which can damage the finish of the knobs. 3. Replace the knobs. Make sure all knobs are turned off.
Control panel	<ul style="list-style-type: none"> • Wash the panel with a sponge and warm, soapy water. Wipe the panel with clean water and dry it well. Do not use steel wool or gritty cleansers, which can damage the finish. <p>OR</p> <ul style="list-style-type: none"> • Wash the panel with a paper towel and spray glass cleaner. Do not spray the cleaner directly on the panel. Apply the cleaner to the paper towel.
Exterior surfaces (other than control panel)	<ul style="list-style-type: none"> • Wash with a sponge and warm, soapy water. Wipe with clean water and dry well. • Use a nonabrasive, plastic scrubbing pad on heavily soiled areas. • Do not use gritty or harsh cleansers, which can damage the finish. <p>NOTE: Do not let foods containing acids (such as vinegar, tomato, or lemon juice) remain on the surface. Acids may remove the glossy finish. Also wipe up milk or egg spills when the cooktop is cool. Be careful when cleaning around the model and serial number plate; too much scrubbing could remove the numbers.</p>
Surface units	<ul style="list-style-type: none"> • You do not have to clean open coil elements because spatters or spills will burn off. • Do not immerse the surface units in water.
Chrome reflector bowls	<ul style="list-style-type: none"> • Wash the reflector bowls with warm, soapy water and a nonabrasive, plastic scrubbing pad. Rinse and dry them well. • Clean the reflector bowls often. • Do not use gritty or harsh cleansers.

continued on next page

CLEANING CHART (CONT.)

PART	HOW TO CLEAN
Broiler pan and grid	<ul style="list-style-type: none"> Wash the pan and grid with a steel-wool pad and warm, soapy water. Rinse and dry well. <p>OR</p> <ul style="list-style-type: none"> Wash the pan and grid in a dishwasher.
Oven racks	<ul style="list-style-type: none"> Wash with a steel-wool pad and warm, soapy water. Rinse and dry well.
Oven door glass (Model RF302BXE)	<ul style="list-style-type: none"> Wash with a paper towel and spray glass cleaner or a nonabrasive plastic scrubbing pad and warm, soapy water. Wipe with clean water and dry well. Follow the directions that come with the cleaner.
Oven cavity	<ul style="list-style-type: none"> Wash with a sponge or steel-wool pad and warm, soapy water. Wipe with clean water and dry well. <p>OR</p> <ol style="list-style-type: none"> Clean heavily soiled areas with a commercial oven cleaner. Follow the directions that come with the oven cleaner. (Place newspaper on the floor to protect the floor surface.) Wipe well with clean water. <p>NOTES:</p> <ul style="list-style-type: none"> Use oven cleaners in a well-ventilated room. Do not let commercial oven cleaners contact the heat seal, thermostat, or exterior surfaces of the range. This will cause damage. For easier cleaning you can remove the oven door. Carefully follow the instructions on page 24.

SURFACE UNITS AND REFLECTOR BOWLS

Removing

1. Make sure all surface units are off and cool before removing surface units and reflector bowls.

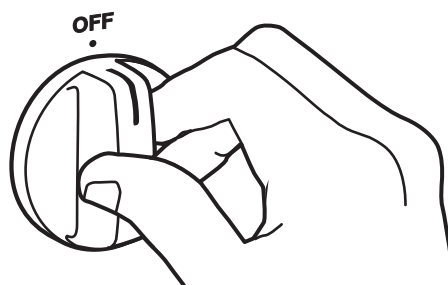

2. Push in the edge of the unit, opposite the receptacle. Then lift it just enough to clear the reflector bowl.

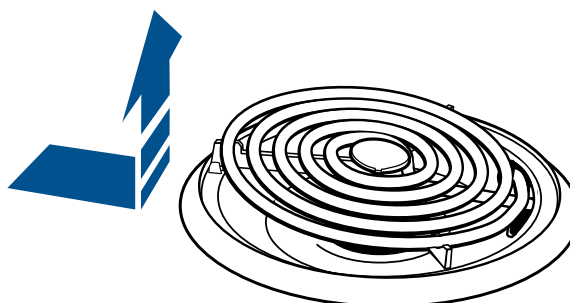

3. Pull the surface unit straight away from the receptacle.

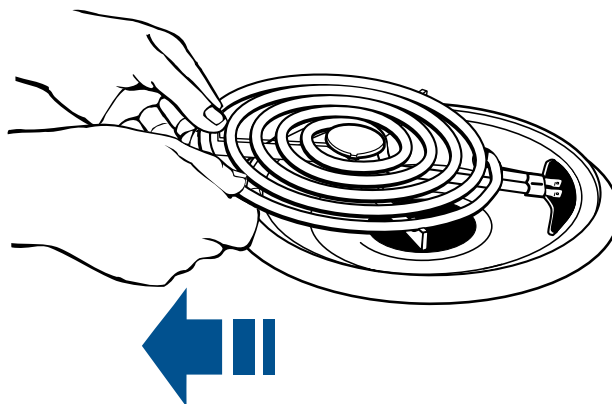

4. Lift out the reflector bowl. See "Cleaning chart" on page 19 for cleaning instructions.



SURFACE UNITS AND REFLECTOR BOWLS (CONT.)

Replacing

1. Make sure all surface units are off and cool before replacing surface units and reflector bowls.

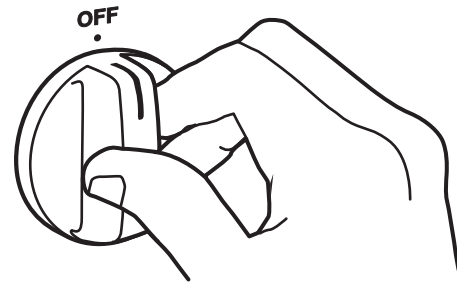

2. Line up openings in the reflector bowl with the surface unit receptacle.

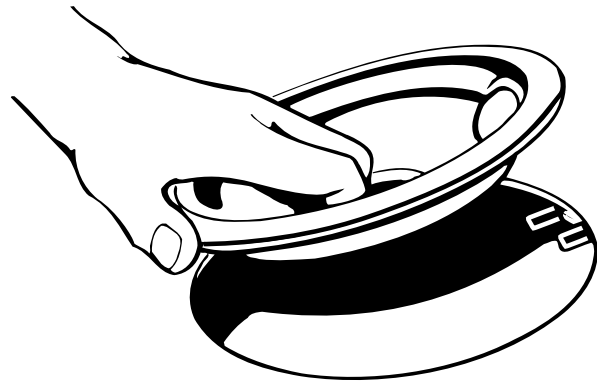

3. Hold the surface unit as level as possible with the terminal just started into the receptacle. Push the surface unit terminal into the receptacle.

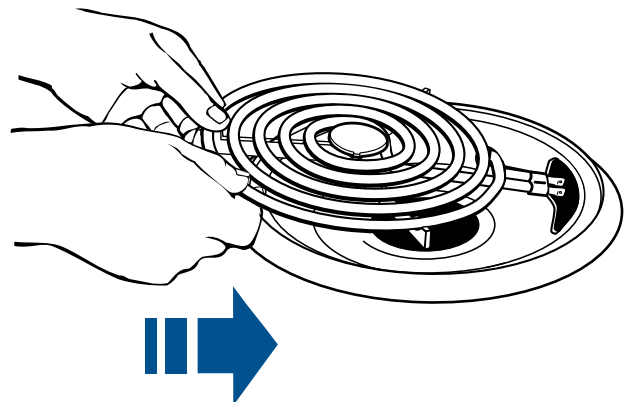

4. When the terminal is pushed into the receptacle as far as it will go, push down the edge of the surface unit opposite the receptacle.

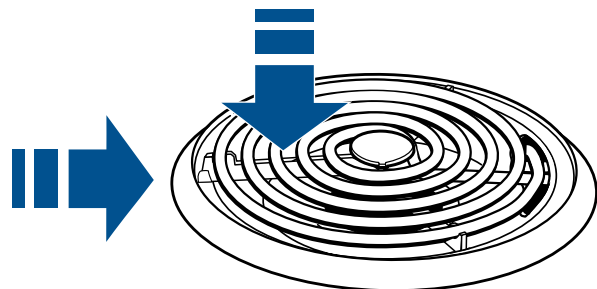

SURFACE UNITS AND REFLECTOR BOWLS (CONT.)

NOTE: Reflector bowls reflect heat back to the cookware on the surface units. They also help catch spills. When they are kept clean, they reflect heat better and look new longer.

If a reflector bowl changes color, some of your cookware may not be flat enough, or some may be

too large for the surface unit. In either case, some of the heat that's meant to go into or around cookware goes down and heats the reflector bowl. This extra heat can cause it to change color.

LIFT-UP COOKTOP

NOTE: Do not drop the cooktop. Damage could result to the porcelain and the cooktop frame.

1. Lift the front of the cooktop at both front corners until the support rods lock into place.
2. Wipe the surface under the cooktop with warm, soapy water and a sponge. Use a soapy steel-wool pad on heavily soiled areas.
3. To lower the cooktop, lift the cooktop from both sides while pressing the support rods back to unlock them. Lower the cooktop into place.

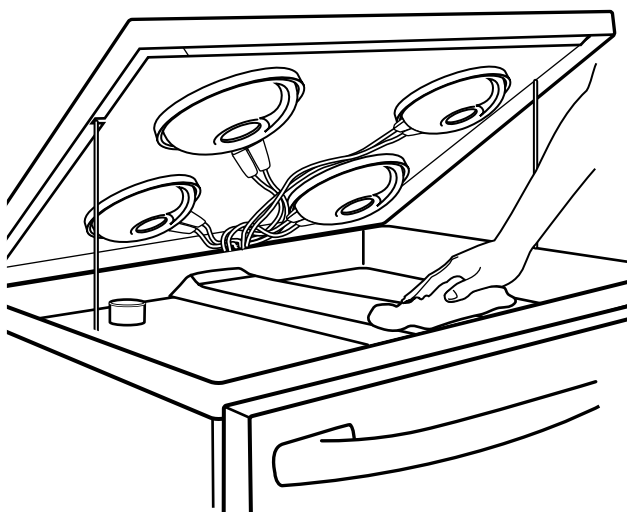

REMOVING THE OVEN DOOR

For normal use of your range, you do not need to remove the door. However, if you have to remove the door follow the instructions in this section.

To remove:

1. Open the door about halfway. Insert nails or screws into both hinge hangers. **Do not remove them while the door is removed from the range.**
2. Close the door as far as the nails or screws will let you.

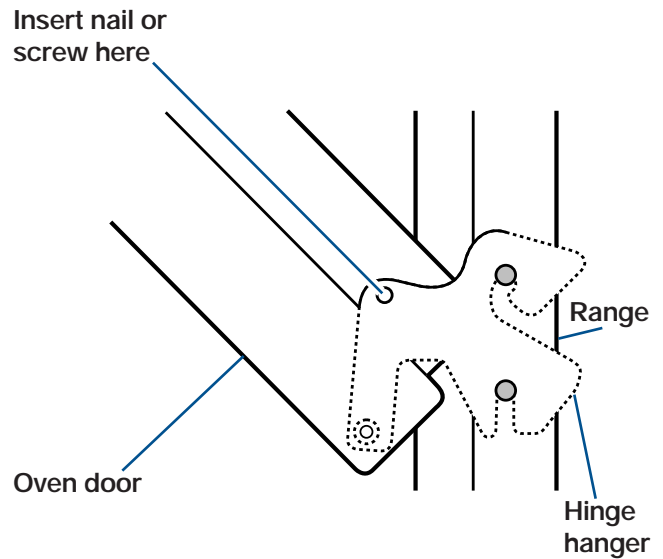

3. Rotate the door toward the range. Lift up the door until it stops. Do not use the door handle to lift the door. Rotate the door toward the floor and pull it toward you.

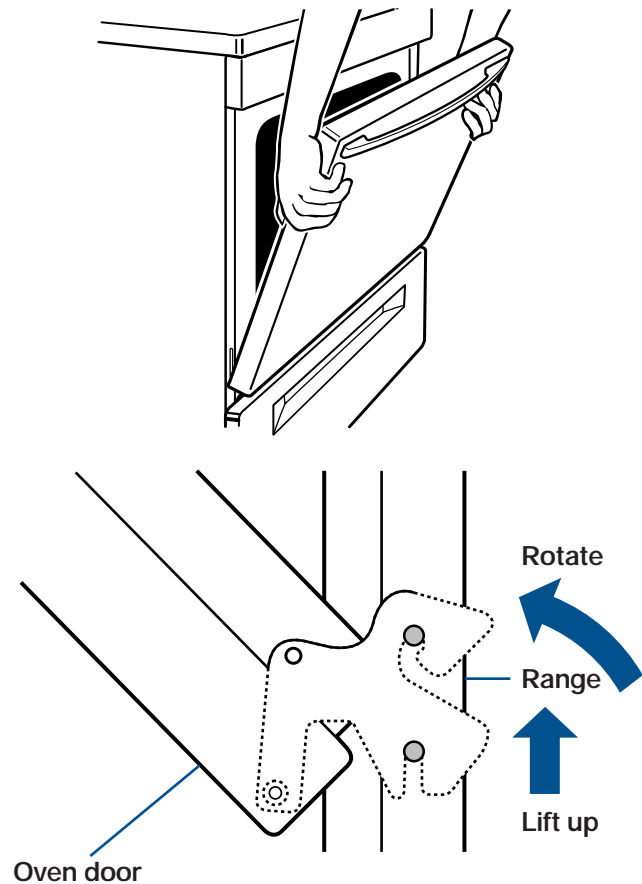

REMOVING THE OVEN DOOR (CONT.)

To replace:

NOTE: The nails or screws you inserted must still be in both sides of the door.

1. Grasp the door on the sides with your fingers on the front of the door and your thumbs on the inside surface.

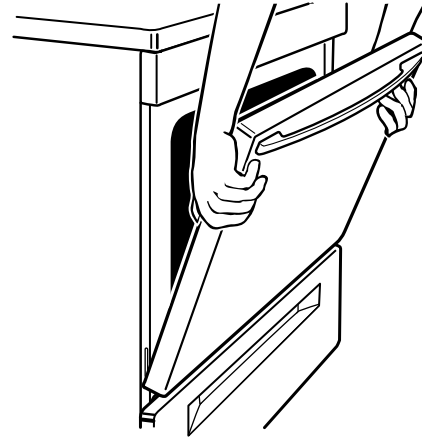

2. Rest the hinge hanger so that it is flat (at the bottom of the hinge hanger on the bottom of the front frame slot).
3. Position the door with the hinge hanger slots almost parallel to the front frame.
4. Push up and in until the hinge hanger slots become fastened to the range. Lower the door and rotate it slightly from the front to the back until the slots are fully fastened. The hinge hanger will be close to the bottom of the front frame slot.
5. Pull door open about halfway and remove the nails or screws.
6. Close the door.

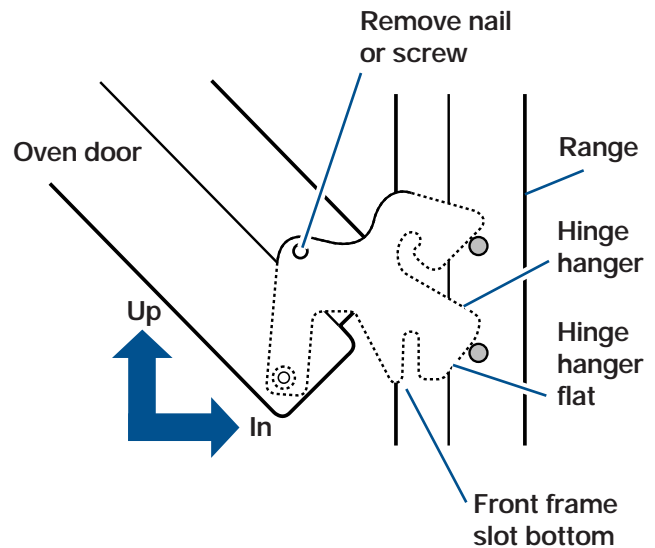

TROUBLESHOOTING

Most cooking problems often are caused by little things you can find and fix without tools of any kind. Check the lists below and on the next page before calling for assistance or service. If you still need help, see “Requesting Assistance or Service” on page 27.

RANGE DOES NOT WORK

PROBLEM	CAUSE
Nothing works	<ul style="list-style-type: none">• The range is not plugged into a live outlet with the proper voltage. (See Installation Instructions.)• You have blown a household fuse or tripped a circuit breaker.• The control knob is not set correctly. Push in the control knobs before turning them.
The oven does not work	<ul style="list-style-type: none">• You have not turned the oven temperature control knob to a temperature setting.• You have not set the oven selector to BAKE or BROIL.
The surface units will not work	<ul style="list-style-type: none">• You have blown a household fuse or tripped a circuit breaker.• The surface units are not plugged in all the way. (See “Replacing” on page 22.)• You have not set the control knobs correctly. Push the control knobs in before turning them to a setting.

COOKING RESULTS

PROBLEM	CAUSE
Cooking results are not what you expected	<ul style="list-style-type: none">• The oven temperature seems too low or too high. See “Adjusting the oven temperature control” on page 13 to adjust the oven temperature.• You did not preheat the oven before baking (if called for in the recipe).• The recipe you are using may need to be altered to improve the taste or appearance of the food.• You are using a pan that is not the correct type or size. Refer to a reliable cookbook or recipe for the recommended pan type and size.• There is not enough air space around the pan when baking. Allow 1½ to 2 inches of air space on all sides of the pan.• The cookware is too large or too small for the surface unit being used. The pan should be the same size or slightly larger than the surface unit being used.• The range is not level. (See the Installation Instructions.)

If none of these items are causing your problem, see “Requesting Assistance or Service” on page 27.

REQUESTING ASSISTANCE OR SERVICE

To avoid unnecessary service calls, please check “Troubleshooting” on page 26. It may save you the cost of a service call. If you still need help, follow the instructions below.

IF YOU NEED ASSISTANCE OR SERVICE

Call the Whirlpool Consumer Assistance Center toll free at 1-800-253-1301. Our consultants are available to assist you.



When calling:

Please know the purchase date, and the complete model and serial number of your appliance (see page 2). This information will help us better respond to your request.

Our consultants provide assistance with:

- Features and specifications on our full line of appliances
- Installation information
- Use and maintenance procedures

- Accessory and repair parts sales
- Do-it-yourself repair help
- Specialized customer assistance (Spanish speaking, hearing impaired, limited vision, etc.)
- Referrals to local dealers, service companies, and repair parts distributors

Whirlpool service technicians are trained to fulfill the product warranty and provide after-warranty service, anywhere in the United States.

To locate the authorized Whirlpool service company in your area, you can also look in your telephone directory Yellow Pages.

IF YOU NEED REPLACEMENT PARTS

If you need to order replacement parts, we recommend that you only use FSP® factory authorized parts. FSP replacement parts will fit right and work right, because they are made to the same exacting specifications used to build every new WHIRLPOOL® appliance.

To locate FSP replacement parts in your area, call our Consumer Assistance Center telephone number or your nearest authorized service center.

FOR FURTHER ASSISTANCE

If you need further assistance, you can write to Whirlpool with any questions or concerns at:

Whirlpool Brand Home Appliances
Consumer Assistance Center
c/o Correspondence Dept.
2000 North M-63
Benton Harbor, MI 49022-2692

Please include a daytime phone number in your correspondence.

If the dealer, authorized servicer, and Whirlpool have failed to resolve your problem, you can contact the Major Appliance Consumer Action Program (MACAP). MACAP is a group of independent consumer experts that voice consumer views at the highest levels of the major appliance industry. MACAP will in turn inform us of your action.

Major Appliance Consumer Action Program
20 North Wacker Drive
Chicago, IL 60606

INDEX

This index is alphabetical. It contains all the topics included in this manual, along with the page(s) on which you can find each topic.

TOPIC	PAGE	TOPIC	PAGE
AIR CIRCULATION	10	MODEL AND SERIAL NUMBER	2
ANTI-TIP BRACKET	17	OVEN DOOR	24
ASSISTANCE	27	OVEN TEMPERATURE	
BAKING		Adjusting	13
Aluminum foil	10	Setting	11, 15
Pans	9, 10	OVEN VENT	17
Racks	9	PANS	9, 10
Setting cycle	11	PARTS	6
Tips	12	RACKS	9
BROILING		ROASTING	
Grid	16	Pans	9, 10
Pan	14, 16	Racks	9
Rack positions	16	Setting cycle	11
Setting cycle	15	Tips	11, 12
Tips	16	SAFETY	3-5
CLEANING		SERVICE	27
Broiler pan and grid	20	STORAGE DRAWER	18
Control knobs	19	SURFACE UNITS	
Control panel	19	Control knobs	7, 19
Exterior surfaces	19	Control setting guide	7
Oven cavity	20	Oven heating indicator light	6
Oven door glass	20	Surface heating indicator light	6
Oven racks	20	Surface unit markers	6
Reflector bowls	19, 21	Tips	7
Surface units	19, 21	TIPS	
CONTROL PANEL		Bakeware	9
Control knobs	7	Cookware	8
Oven heating indicator light	6	Roasting	11
Surface heating indicator light	6	Saving energy	7, 12
Surface unit markers	6	TROUBLESHOOTING	26
COOKWARE		WARRANTY	32
Canning	8		
Tips	8		
FEATURES	6		
LIFT-UP COOKTOP	23		

WARRANTY

WHIRLPOOL® ELECTRIC RANGE

LENGTH OF WARRANTY	WHIRLPOOL WILL PAY FOR
FULL ONE-YEAR WARRANTY FROM DATE OF PURCHASE	FSP® replacement parts and repair labor to correct defects in materials or workmanship. Service must be provided by an authorized Whirlpool service company.
WHIRLPOOL WILL NOT PAY FOR	
<p>A. Service calls to:</p> <ol style="list-style-type: none"> 1. Correct the installation of your range. 2. Instruct you how to use your range. 3. Replace house fuses or correct house wiring. 4. Replace owner-accessible light bulbs. <p>B. Repairs when your range is used in other than normal, single-family household use.</p> <p>C. Pickup and delivery. Your range is designed to be repaired in the home.</p> <p>D. Damage to your range caused by accident, misuse, fire, flood, acts of God, or use of products not approved by Whirlpool.</p> <p>E. Repairs to parts or systems caused by unauthorized modifications made to the appliance.</p>	

3/96

WHIRLPOOL CORPORATION SHALL NOT BE LIABLE FOR INCIDENTAL OR CONSEQUENTIAL DAMAGES. Some states do not allow the exclusion or limitation of incidental or consequential damages, so this exclusion or limitation may not apply to you. This warranty gives you specific legal rights, and you may also have other rights which vary from state to state.

Outside the United States, a different warranty may apply. For details, please contact your authorized Whirlpool dealer.

If you need service, first see the "Troubleshooting" section of this book. After checking "Troubleshooting," additional help can be found by checking the "Requesting Assistance or Service" section, or by calling our Consumer Assistance Center telephone number, **1-800-253-1301**, from anywhere in the U.S.A.